

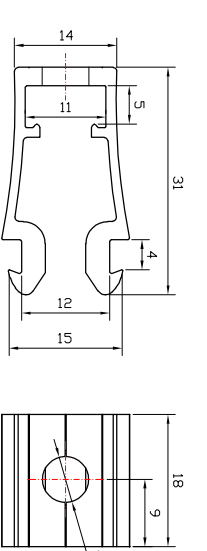

ROMAGNOLE
CÓPIA NÃO CONTROLADA
Somente Para Informação

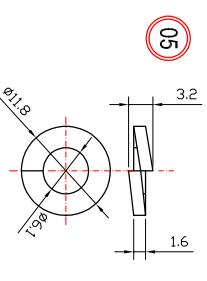
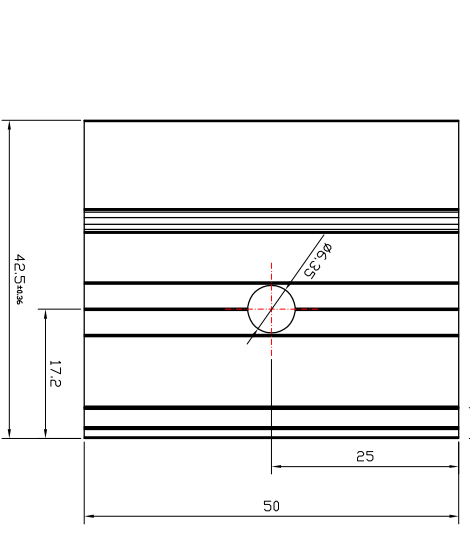
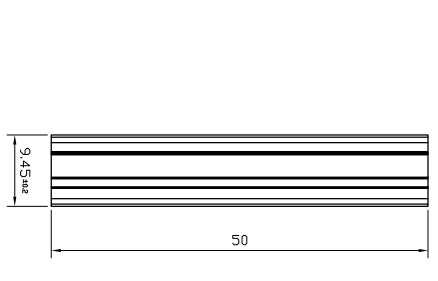
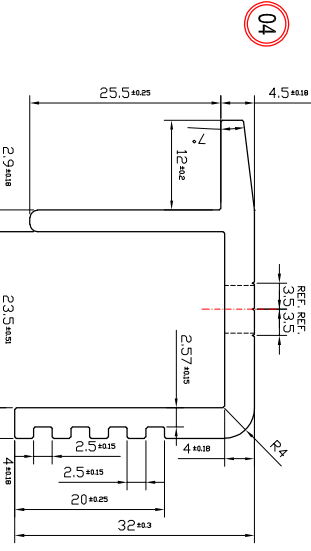
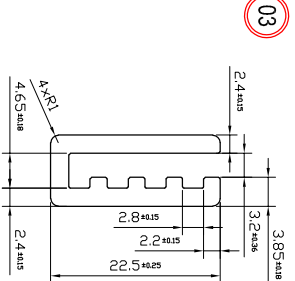
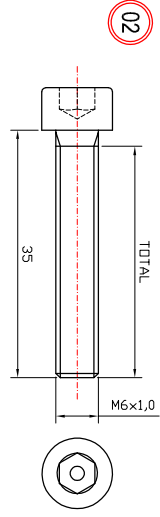
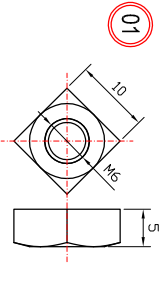
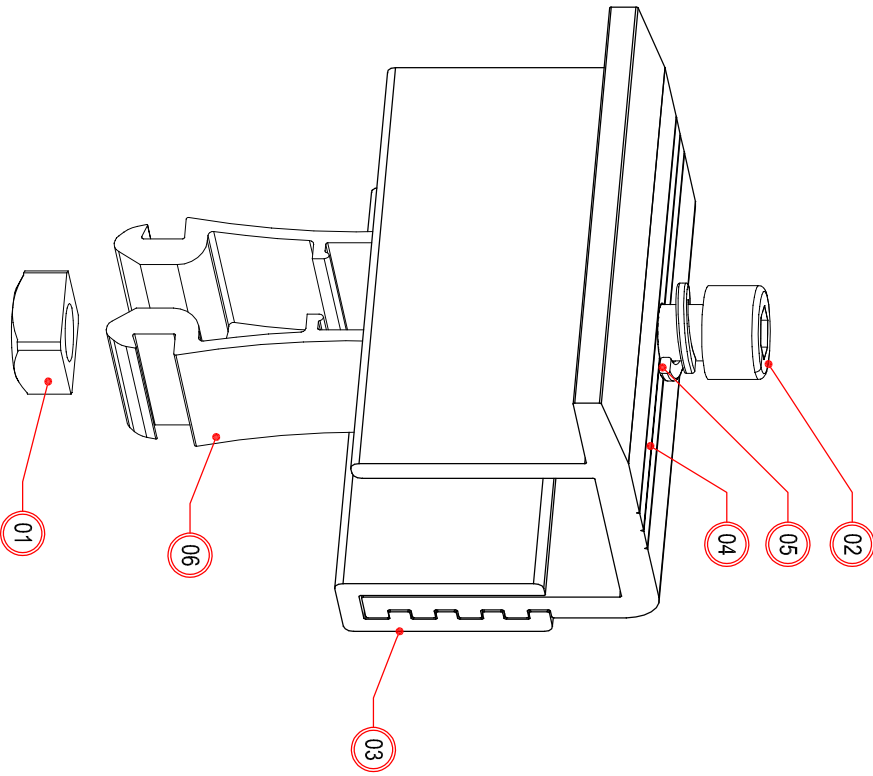

ITEM	QUANT.	DESCRIÇÃO	DIMENSÕES	MATERIAL
06	01	PERFIL PRESILHA 2	15x31x14x18mm	ALUMINIO 6063-T6
05	01	ARRUELA DE PRESSÃO	M6	INOX
04	01	PERFIL PRESILHA SUPERIOR	42.5x32x50mm	ALUMINIO 6063-T6
03	01	PERFIL PRESILHA REGULAGEM	9.45x22.5x50mm	ALUMINIO 6063-T6
02	01	PARAFUSO ALLEN	M6x35mm	INOX
01	01	PORCA QUADRADA	M6	INOX

ELABORAÇÃO		VERIFICAÇÃO		APROVAÇÃO		DATA		UNID. MED.		ESCALA		DBS. Nº	
JESSICA		ANDRÉ		EVANDRO		25/03/2020		mm		S / E		RS-297	
 END CLAMP REGULAVEL FRAME 30, 35 E 40MM													

Este Documento é de autoria da empresa Romagnole Produtos Elétricos S.A., e protegido pela Lei de Direitos Autorais. Sua reprodução ou compartilhamento a terceiros, sem a expressa autorização da Romagnole, será caracterizado como crime, estando o infrator sujeito as imputações legais.